

Hafa® Spegel Store Rund LED 700, 1000

Art.nr 1267220, 1267221

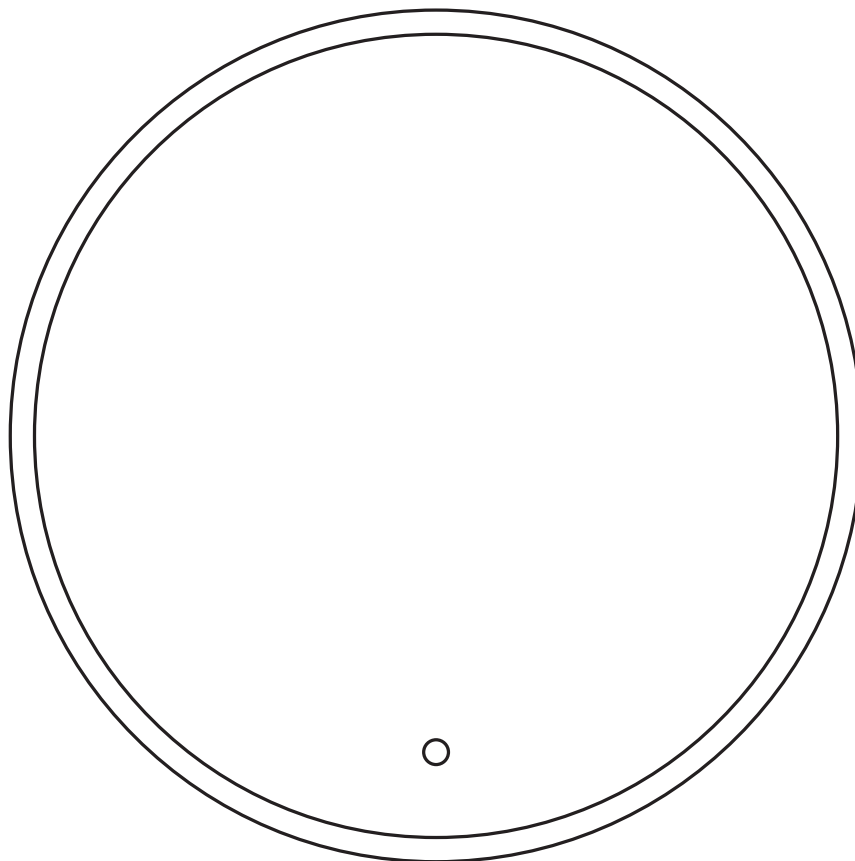

CE IP44

- SE** Denna produkt innehåller en ljuskälla med energieffektivitetsklass E
DK Dette produkt indeholder en lyskilde i energieffektivitetsklasse E
NO Dette produktet inneholder en lyskilde med energieffektivitetsklasse E
FI Tämä tuote sisältää valonlähteen, jonka energiatehokkuusluokka on E
ENG This product contains a light source of energy efficiency class E

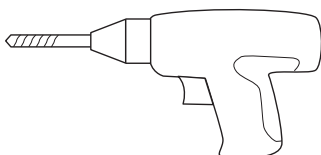

Hafa®

Hafa
Svarvaregatan 5, Box 525
SE-301 80 Halmstad
SWEDEN

Garanti/Warranty.
Service, reservdelar/spare parts
Sweden: Tel: +46 (0)35 15 44 75
Norway: Tel: +47 (0)69 31 02 30
Finland: Puh: +358 (0)9 61500940

www.hafa.se
www.hafa.dk
www.hafabad.no
www.hafa.se
www.hafabathroom.ru
www.hafa.eu

E-mail:
service@hafa.se
service@hafabad.no

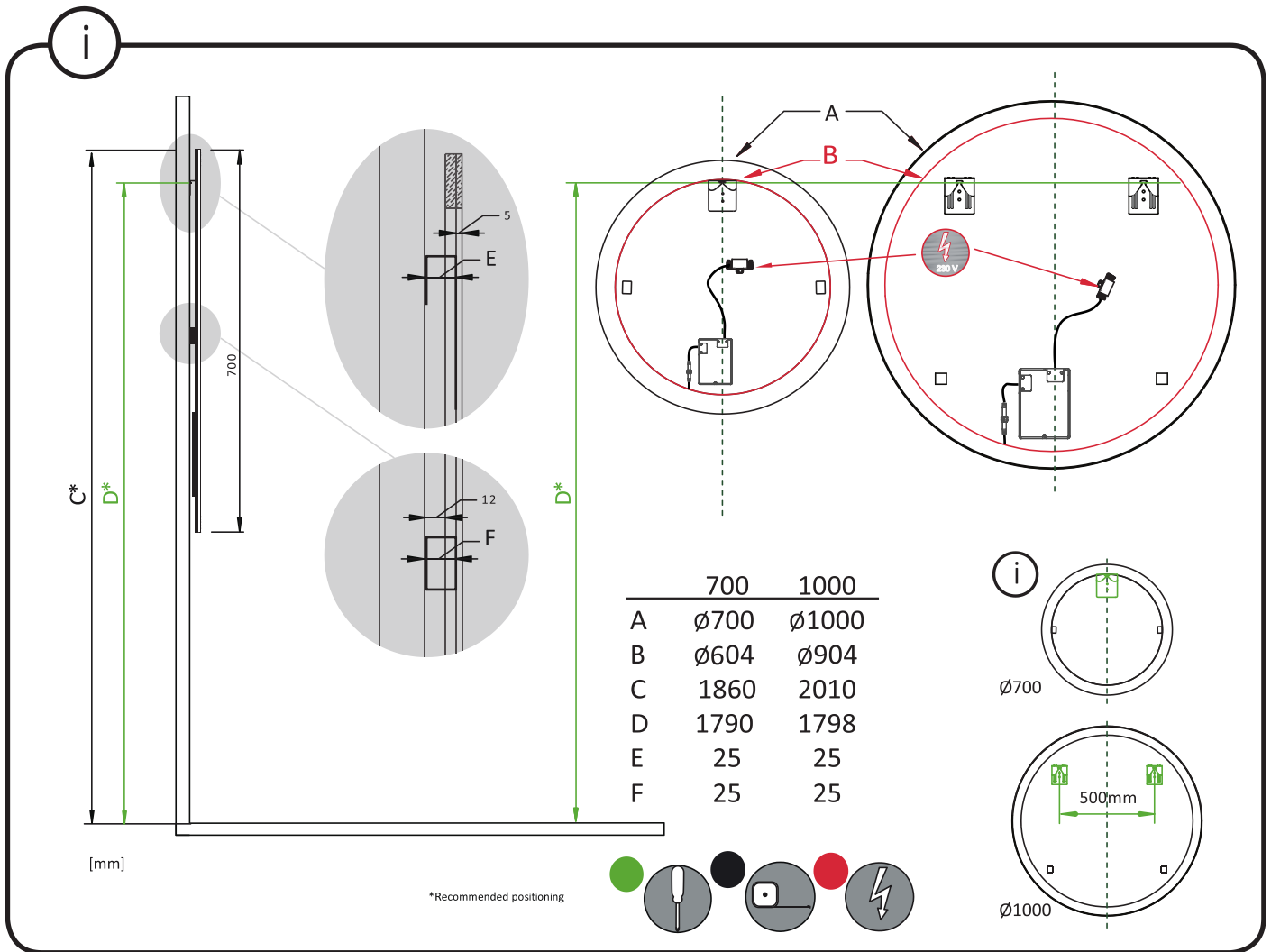

1

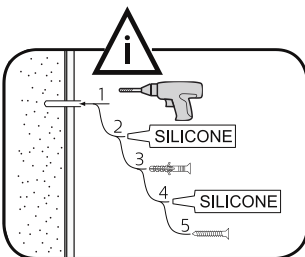

i

OBS! Använd skruv som passar ditt väggmaterial
OBS! Brug den skrue, der passer til dine vægmaterialer
OBS! Bruk skruer som passer til veggmaterialet
HUOM! Käytä seinämateriaaliin sopivaa ruuvia
NOTE! Use screws suitable for your wall material

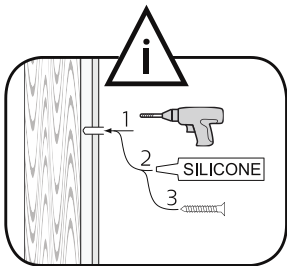

Läs mer på sid 4
 Read more on page 4

i

OBS! Borra aldrig hål i väggen utan att först ha kontrollerat måtten på det aktuella exemplaret.
OBS! Bor aldri hull i veggen uten å først kontrollere dimensjonene av den nåværende element.
OBS! Bor aldrig huller i väggen uden først at kontrollere dimensionerne af den nuværende vare.
HUOM! Ennen poraamista-tarkistathan reikian mittasuhteet tuotteestasi.
NOTE! Before drilling any holes to the wall always check the position for the fixtures for the product itself.

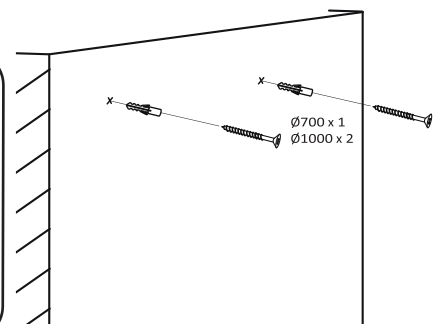

2



230 V
OBS! Endast behörig elektriker
OBS! Må bare monteres av autorisert elektriker
OBS! Skal tilsluttes af autoriseret elektriker
HUOM! Vain asianmukainen sähkömiehes
NOTE! Authorized personnel only

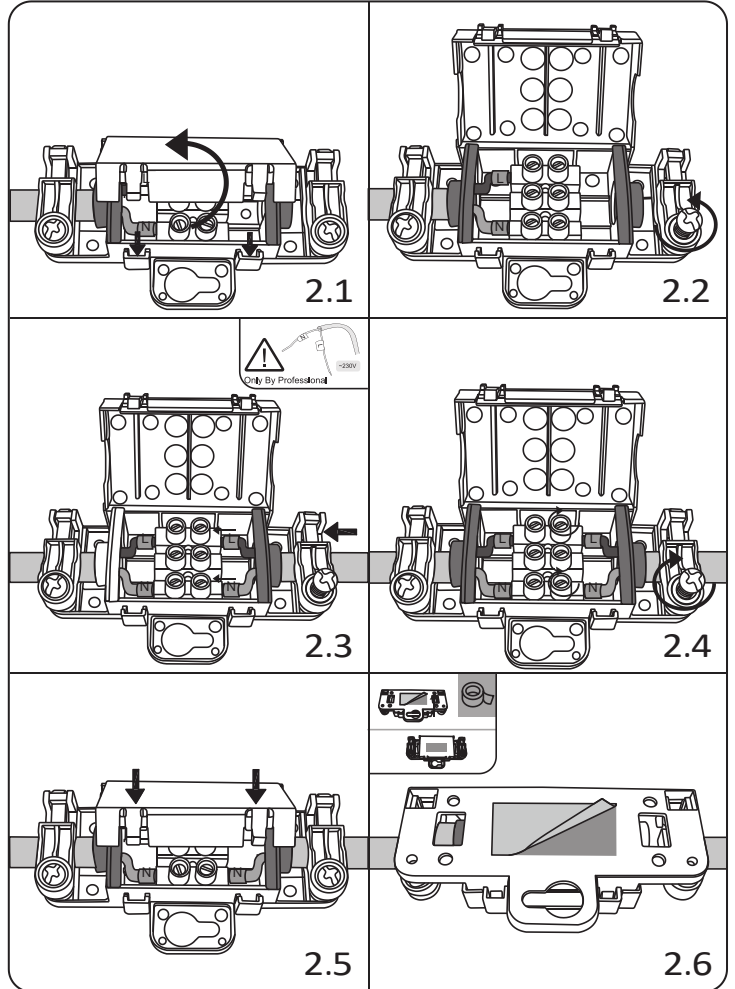
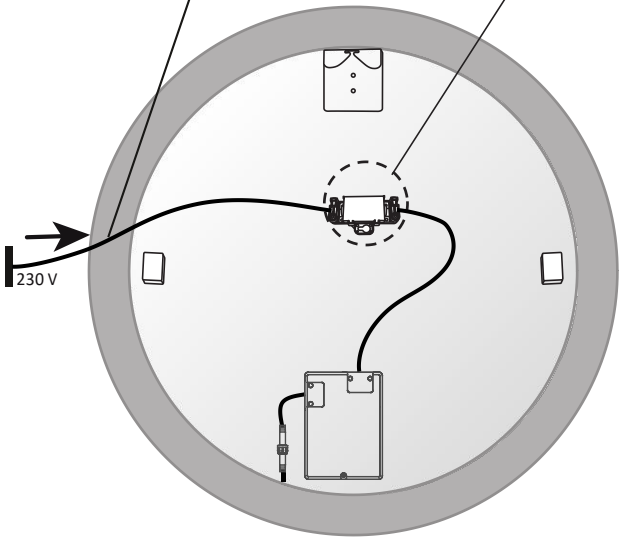

3

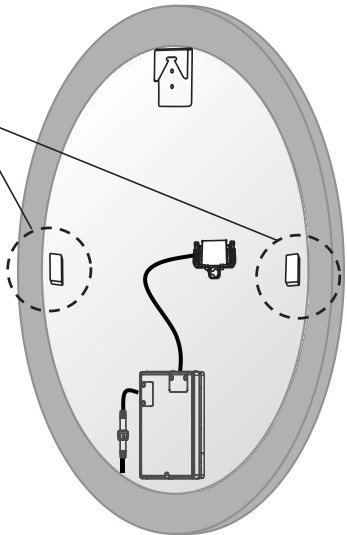
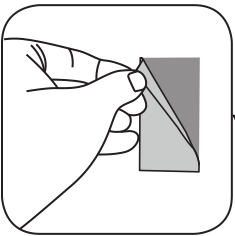

4

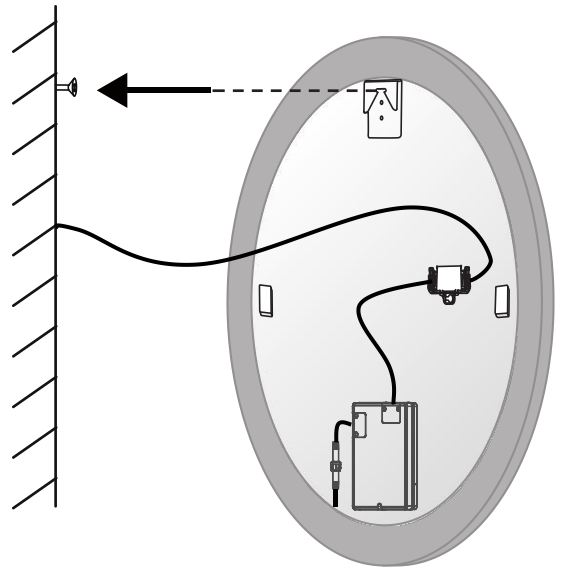

i

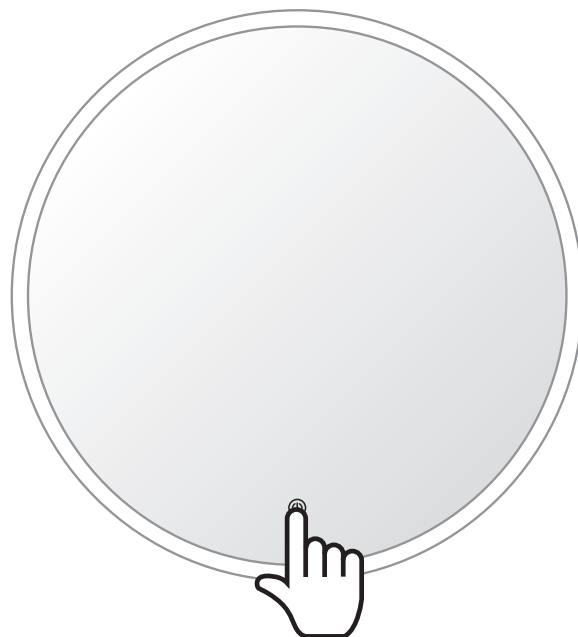

ON / OFF

>1S. ☀ ▲ ☀

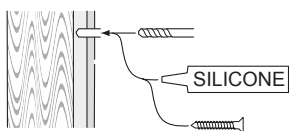

alt.

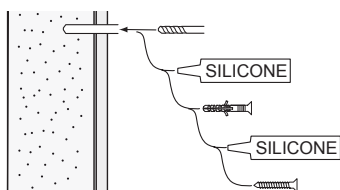

SE

Skruvfästningar ska göras i betong eller annan massiv konstruktion, träreglar, träkortlingar eller i konstruktion som är provad och godkänd för infästning, till exempel skivkonstruktion. Se exempel på godkända konstruktioner på sakervatten.se. Material för tätning ska fästa mot underlaget och vara vattenbeständigt, mögelresistent och åldersbeständigt. Krav på tätning gäller både i våtzon 1 och 2.

GB

*Below are Swedish recommendations:
Screw fastenings should be made in concrete or other solid structure, wooden studs, wooden noggings or in structures that have been tested and approved for fastenings, for example a sheet construction. See examples of approved constructions at sakervatten.se. Sealing substances must fixate to the materials it aims to seal, be waterproof, mould-resistant and age-resistant. Requirements for sealing apply in wet zones 1 and 2.*

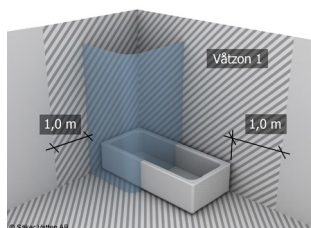

Hafa[®]

Hafa
Svarvaregatan 5, Box 525
SE-301 80 Halmstad
SWEDEN

Garanti/Warranty.
Service, reservdelar/spare parts
Sweden: Tel: +46 (0)35 15 44 75
Norway: Tel: +47 (0)69 31 02 30
Finland: Puh: +358 (0)9 61500940

www.hafa.se
www.hafa.dk
www.hafabad.no
www.hafa.se
www.hafabathroom.ru
www.hafa.eu

E-mail:
service@hafa.se
service@hafabad.no